

Portable CD Player

AX 2330

User manual
Manuel d'utilisation
Manual del usuario
Gebruikershandleiding



PHILIPS

Meet Philips at the Internet
<http://www.philips.com>

English

Français

Español

Nederlands

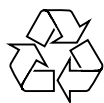

AX 2330

**CLASS 1
LASER PRODUCT**



Printed in China

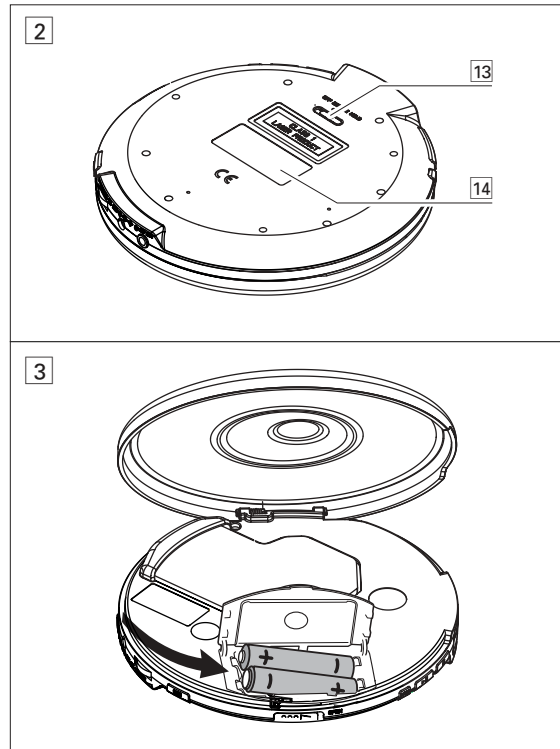
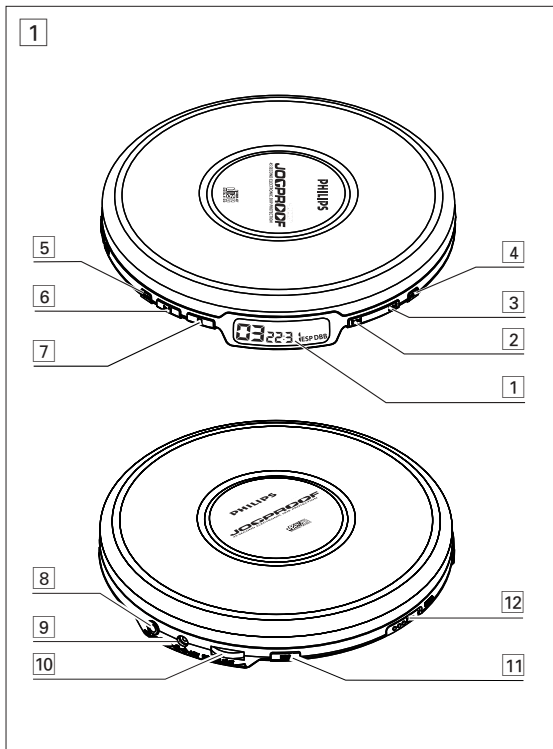

QUICK START

MISE EN SERVICE RAPIDE

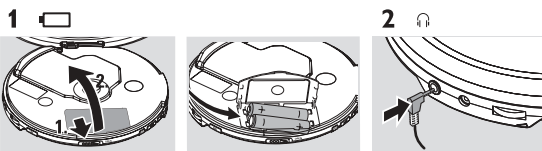

English

CONTROLS / POWER SUPPLY

CONTROLS (see figure 1, 2)

- 1display
- 2 ◀◀skips and searches CD tracks backwards
- 3 ▶▶skips and searches CD tracks forwards
- 4 PROG.....programs tracks and reviews the program
- 5 MODEselects the different playing possibilities: **SHUFFLE**, **SHUFFLE REPEAT ALL**, **REPEAT**, **REPEAT ALL** and **SCROLL**
- 6 ▶||switches the player on, starts or pauses CD play
- 7 ■stops CD play, clears a program or switches the player off
- 8 LINE OUT/🔊3.5 mm headphone socket, socket to connect the player to another audio input of an additional appliance.
- 9 4.5V DC.....socket for external power supply
- 10 VOL ◀adjusts the volume
- 11 DBB.....switches the bass enhancement on and off. This button also switches acoustic feedback (the beep) on/off when it is pressed for more than 2 seconds
- 12 ▶ OPENopens the CD lid
- 13 RESUMEstores the last position of a CD track played
HOLD.....locks all buttons
OFF.....switches RESUME and HOLD off
- 14type plate

CAUTION

Use of controls or adjustments or performance of procedures other than herein may result in hazardous radiation exposure.

Batteries (supplied or optionally available)

You can use the following batteries with this CD-player:

- normal batteries type **LR6**, **UM3** or **AA**, or
- alkaline batteries type **LR6**, **UM3** or **AA**.

Notes:— Old and new or different types of batteries should not be combined.

— Remove batteries if they are empty or if the player is not going to be used for a long time.

Inserting batteries (see figure 3)

- 1 Push OPEN ▶ to open the CD lid.
- 2 Open the battery compartment and insert either 2 normal or alkaline batteries.

Battery indication

The approximate power level of your batteries is shown in the display.

🔋 Battery full

🔋 Battery two-thirds full

🔋 Battery one-third full

🔋 Battery dead or empty. When the batteries are dead or empty, the symbol 🔋 flashes, **6RtE** is displayed, and the beep tone sounds repeatedly.



Batteries contain chemical substances, so they should be disposed of properly.

Both the model number and production number are located on the bottom of the set.

POWER SUPPLY / GENERAL INFORMATION

Mains adapter (supplied or optionally available)

Use only the adapter (4.5 V / 450 mA direct current, positive pole to the center pin). Any other product may damage the player.

- 1 Make sure the local voltage corresponds to the power adapter's voltage.

- 2 Connect the power adapter to the 4.5V DC socket of the player and to the wall socket.

Note: Always disconnect the adapter when you are not using it.

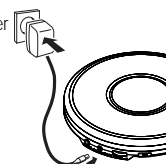

Environmental information

- All redundant packing material has been omitted. We have done our utmost to make the packaging easily separable into two materials: cardboard (box) and polyethylene (bags, protective foam sheet).
- Your set consists of materials which can be recycled if disassembled by a specialized company. Please observe the local regulations regarding the disposal of packing materials, exhausted batteries and old equipment.

This product complies with the radio interference requirements of the European Union.

CD player and CD handling

- Do not touch the lens (A) of the CD player.
- Do not expose the unit, batteries or CDs to humidity, rain, sand or excessive heat (caused by heating equipment or direct sunlight).
- You can clean the CD player with a soft, slightly dampened, lint-free cloth. Do not use any cleaning agents as they may have a corrosive effect.
- To clean the CD, wipe it in a straight line from the center toward the edge using a soft, lint-free cloth. A cleaning agent may damage the disc! Never write on a CD or attach a sticker to it.
- The lens may cloud over when the unit is moved suddenly from cold to warm surroundings. Playing a CD is not possible then. Leave the CD player in a warm environment until the moisture has evaporated.
- Active mobile phones in the vicinity of the CD player may cause malfunctions.
- Avoid dropping the unit as this may cause damage.

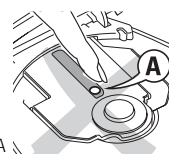

Headphones HE 035

- Connect the supplied headphones to the LINE OUT/🔊 jack of the player.

Note: LINE OUT/🔊 can also be used for connecting this set to your HiFi system. To adjust the sound and volume, use the controls on the connected audio equipment and on the CD player.

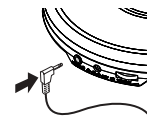

IMPORTANT!

Hearing safety: Do not play your headphones at a high volume. Hearing experts advise that continuous use at high volume can permanently damage your hearing.

Traffic safety: Do not use headphones while driving a vehicle. It may create a hazard and it is illegal in many countries. Even if your headphones are an open-air type designed to let you hear outside sounds, do not turn up the volume so high that you cannot hear what is going on around you.

GENERAL INFORMATION / CD PLAY

In-car use (connections supplied or optionally available)

Only use the a 4.5 V DC Car voltage converter (positive pole to the centre pin) and car adapter cassette. Any other product may damage the set.

- Put the set on a horizontal, vibration-free and stable surface. Make sure it is in a safe place, where the set is neither a danger nor an obstacle to the driver and the passengers.
 - Plug the voltage converter into the cigarette lighter socket (**only for 12 V car battery, negative grounding**), then connect the wired end with 4.5V DC input socket on the set.
 - If necessary, clean the cigarette lighter socket to obtain a good electrical contact.
 - Turn down the volume and connect the cassette adapter plug to LINE OUT/⏏ on the set.
 - Carefully insert the cassette adapter into the car radio's cassette compartment.
 - Make sure the cord does not hinder your driving.
 - Decrease the volume on the set, if necessary. Start playback on the set and adjust the sound with the car radio controls.
- Always remove the voltage converter from the cigarette lighter socket when the set is not in use.**

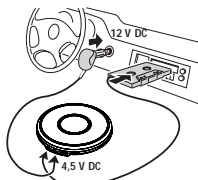

Note: If your car radio has a LINE IN socket, it is better to use it for the car radio connection instead of the cassette adapter. Connect the signal lead to this LINE IN socket and to LINE OUT/⏏ on the set.

CD PLAY / FEATURES

Playback information

- If a CD-Recordable (CD-R) or a CD-Rewritable (CD-RW) is not recorded properly, **RF 15E** is displayed, indicating that the CD has not been finalized. In that case, use FINALIZE on your CD recorder to complete the recording.
- When playing a CD-Rewritable (CD-RW), please note that it takes 3–15 seconds after pressing **▶||** for sound reproduction to start.
- Playback will stop and the set will turn off if you open the CD lid.
- While the CD is read, **CD** flashes in the display.

Volume and bass

Volume adjustment

- Adjust the volume by using VOL



Bass adjustment

- Press DBB to switch the bass enhancement on or off.
 - **DBB** appears if the bass enhancement is activated.



Playing a CD

This CD-player can play all kinds of **Audio Discs** such as CD-Recordables and CD-Rewritables. Do not try to play a CD-ROM, CDi, VCD, DVD or computer CD.

- Push the OPEN **▶** slider to open the player.
 - Insert an audio CD, printed side up, by pressing the CD onto the hub.
 - Close the player by pressing the lid down.
 - Press **▶||** to switch the player on and start playback.
 - The current track number and elapsed playing time are displayed.
 - You can pause playback by pressing **▶||**.
 - The time at which playback was paused starts flashing.
 - You can continue playback by pressing **▶||** again.
 - Press **■** to stop playback.
 - The total number of tracks and the total playing time of the CD are displayed.
 - Press **■** again to switch the player off.
- To remove the CD, hold it by its edge and press the hub gently while lifting the CD.

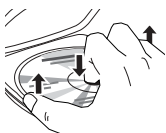
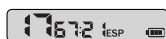
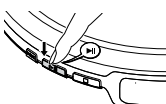
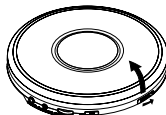

Note: If there is no activity, the set will automatically switch off after a while to save energy.

Selecting a track and searching

Selecting a track during playback

- Briefly press **◀◀** or **▶▶** once or several times to skip to the current, previous or next track.
 - Playback continues with the selected track, and the track's number is displayed.

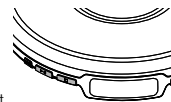

Selecting a track when playback is stopped

- Briefly press **◀◀** or **▶▶** once or several times to select the desired track. The track number is displayed.
- Press **▶||** to start CD play.
 - Playback starts with the selected track.

Searching for a passage during playback

- Keep **◀◀** or **▶▶** pressed to find a particular passage in a backward or forward direction.
 - Searching starts while playback continues at low volume. After 2 seconds the search speeds up.
- Release the button when you reach the desired passage.
 - Playback continues from this position.

Notes: – If the player is in SCAN mode (see MODE chapter), searching is not possible.
 – In shuffle, shuffle repeat all or repeat mode (see MODE chapter), or while playing a program, searching is only possible within the particular track.

FEATURES

Programming track numbers

You can store up to 30 tracks to play in a program. A single track may be stored more than once in the program.

- 1 While playback is stopped, select a track with ◀◀ or ▶▶.
- 2 Press PROG to store the track.
→ **PROG** lights up; the track number programmed and **P** with the total number of stored tracks are displayed.
- 3 Select and store all desired tracks in this way.
- 4 Press ▶▶ to start playback of your selected tracks.
→ **PROG** is shown and playback starts.

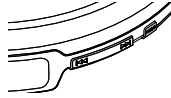

- You can review the program by pressing PROG for more than 2 seconds.
→ The display shows all the stored tracks in sequence.

Notes: – If you press PROG and there is no track selected, **PROG** is displayed.
– If you try to store more than 30 tracks, **FULL** is displayed.



Clearing the program

- While playback is stopped, press ■ to clear program.
→ **CLR** is displayed once, **PROG** goes off, and the program is cleared.



Note: The program will also be cleared if the power supply is interrupted, or if the CD-player lid is opened, or if the set switches off automatically.

Selecting different playing possibilities-MODE

It is possible to play tracks in random order, to repeat a single track or the entire CD, and to play the first few seconds of each track.

- 1 Press MODE during playback as often as required in order to activate one of the following 'modes'. The active mode is shown in the display.
→ **SHUFFLE**: All tracks of the CD are played in random order until all of them have been played once.
→ **SHUFFLE REPEAT ALL**: All tracks of the CD are played repeatedly in random order.
→ **REPEAT**: The current track is played repeatedly.
→ **REPEAT ALL**: The entire CD is played repeatedly.
→ **5 S**: The first 10 seconds of each of the remaining tracks are played in sequence.
 - 2 Playback starts in the chosen mode after 2 seconds.
- To return to normal playback, press MODE repeatedly until the display shows no active modes.

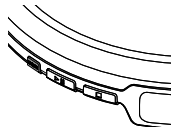

ESP

With a conventional portable CD-player you might have experienced that the music stopped e.g. when you were jogging. The Electronic Skip Protection prevents loss of sound caused by light vibrations and shocks. Continuous playback is ensured. However ESP does not prevent playback interruptions during vigorous running. It also does not protect the unit against any damage caused by dropping!

In this set ESP is default ON. It is possible to set ESP off.

- Press MODE for more than 2 seconds.
→ **ESP** disappears.
- Press MODE again for more than 2 seconds.
→ **ESP** is displayed.

ESP on ⇒ **ESP off** ⇒ **ESP on**

FEATURES / TROUBLESHOOTING

RESUME and HOLD

You can interrupt playback and continue (after up to 1 minute in the disc stop position only) from the position where playback stopped (RESUME). You can lock all buttons of the set so that no action will be executed (HOLD). Use the RESUME-HOLD-OFF slider for these functions.

RESUME – continuing from where you have stopped

- 1 Switch the slider to RESUME during playback to activate RESUME.
→ **RESUME** is shown.
 - 2 Press ■ whenever you want to stop playback.
 - 3 Press ▶▶ whenever you want to resume playback.
→ **RESUME** is shown and playback continues from where you have stopped.
- To deactivate RESUME, switch the slider to OFF.
→ **RESUME** goes off.

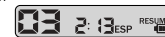
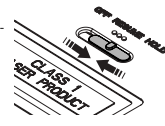

HOLD – locking all buttons

You can lock the buttons of the set by switching the slider to HOLD. Now, when a key is pressed, no action will be executed. This is of use, for example, when transporting the player in a bag. With HOLD activated, you can avoid accidental activation of other functions.

- 1 Switch the slider to HOLD to activate HOLD.
→ All buttons are locked. **Hold** is shown when you press any button. If the set is switched off, **HOLD** will be shown only when ▶▶ is pressed.
- 2 To deactivate HOLD, switch the slider to OFF.



Note: If you deactivate HOLD by switching the slider to RESUME, you will be activating the RESUME function.

Troubleshooting

WARNING: Under no circumstances should you try to repair the set yourself as this will invalidate the warranty. If a fault occurs, first check the points listed, before taking the unit for repair. If you are unable to solve a problem by following these hints, consult your dealer or service center.

The CD player has no power, or playback does not start

- Check that your batteries are not dead or empty, that they are inserted correctly, that the contact pins are clean.
- Your adapter connection may be loose. Connect it securely.
- For in-car use, check that the car ignition is on. Also check player's batteries.

The indication **NO DISC** is displayed

- Check that the CD is clean and correctly inserted (label-side upward).
- If your lens has steamed up, wait a few minutes for this to clear.

The indication **RF DISC** is displayed

- CD-RW (CD-R) was not recorded properly. Use FINALIZE on your CD-recorder.

The indication **HOLD** is on and/or there is no reaction to controls

- If HOLD is activated, then deactivate it.
- Electrostatic discharge. Disconnect power or remove batteries for a few seconds.

The CD skips tracks

- The CD is damaged or dirty. Replace or clean the CD.
- RESUME, SHUFFLE or PROGRAM is active. Switch off whichever is on.

No sound or bad sound quality.

- PAUSE might be active. Press ▶▶.
- Loose, wrong or dirty connections. Check and clean connections.
- Volume might not be appropriately adjusted. Adjust the volume.
- Strong magnetic fields. Check player's position and connections. Also keep away from active mobile phones.
- For in-car use, check that the cassette adapter is inserted correctly, that the car cassette player's playback direction is correct (press autoreverse to change), and that the cigarette lighter jack is clean. Allow time for temperature change.